

## RADIO SIGNAL SUPPRESSION FOR TELEPHONE SETS

### 1. GENERAL

**1.01** This section contains information on the reduction of radio interference in telephone sets.

**1.02** This section is reissued to:

- Add information on single slot coin telephones
- Show 241A amplifier replaced by 241B amplifier.

**1.03** Radio interference frequently occurs where a radio station transmitter is located near telephone facilities. Generally the radio signal is picked up by the wire, which acts as an antenna, and demodulated (changed to audio frequency) by nonlinear components, such as varistors, transistors, and diodes in the telephone set. ***However demodulation can also result from corroded connections and loose terminations.***

**1.04** Before ordering a telephone set modified for radio signal suppression, check for the following:

- Corroded connections (inside and outside plant)
- Loose wire terminations (including set wiring)
- Abandoned drop wire still connected to line
- Inside wire connected but not used
- Foreign attachments.

Installing a modified telephone set on the customers premises will not be effective if demodulation is caused by any of the above conditions.

**1.05** Telephone set components that may act as demodulators are:

- Speech equalization varistors in networks

- Transistors in amplifiers of some networks and handsets

- Varistors and transistors in TOUCH-TONE® dials

- Diodes in polarity guards

- Click suppression varistors across receiver units

- Carbon transmitters

**1.06** With the introduction of the 425J and 4010E networks, the cause of radio signal demodulation in networks has effectively been minimized. In these networks the speech equalization varistors have been replaced by resistors and a strapping option which provides speech equalization.

**1.07** All telephone sets, excluding coin, will be available from the local distributing house modified for radio signal suppression. Modification will include changing to new type network, where applicable, and placing bypass capacitors across all other components that may act as demodulators as listed in 1.05.



***Before ordering a modified telephone set make sure that demodulation is not occurring external to the telephone set (See 1.04).***

**1.08** ♦ Single slot coin telephones are not modified at the service center, and where radio frequency is a problem, it is recommended that a 40BA capacitor and/or a 1542A inductor be added at the protector and connecting block. ♦

**1.09** Where demodulation is attributed to components in a telephone set, or associated voice coupler, in addition to changing to a modified set it is recommended that a 40BA capacitor be placed at the protector and a 1542A inductor at the connecting block. Refer to section in Division 463 for voice coupler modifications. The capacitor will bypass, to ground, radio signals picked up by the

**SECTION 500-150-100**

drop wire while the inductor will tend to attenuate radio signals picked up by the inside wire.

**1.10** Where an adjunct (TOUCH-TONE phone) dial forms a part of the customers equipment and a modified telephone set is installed for radio interference reasons, the adjunct dial should also be replaced by one modified for radio suppression.

**1.11** MD telephone sets will not be modified for radio suppression. Where a telephone set rated MD is encountered, it should be replaced by an equivalent set in the current series, modified for radio suppression.

**1.12** If possible, arrange for operation of the radio station during the trouble visit in order that the effectiveness of corrective measures taken may be evaluated immediately.

**2. IDENTIFICATION**

**2.01 Suppression Devices:**

(a) 425J Network (Fig. 1):

- Eliminates radio interference by having the speech equalization varistors replaced by resistors and a strapping option ("H" and "J" leads)
- Can be used for rotary or TOUCH-TONE dial applications

- Contains an equalization network for TOUCH-TONE dials ("X" Terminal)

(b) 4010E Network (Fig. 2):

- Similar to 425J
- Strapping option consists of "N" and "V" leads

(c) 1542A Inductor (Fig. 3):

- Attenuates RF line current
- Can be substituted for the 42A connecting block.
- Removable link between terminals B and Y (current models only). Required when used as connecting block for telephone sets with dial lamps or with 30A voice coupler.

(d) 40BA Capacitor (Fig. 4):

- Located at protector to bypass RF signals to ground.

**2.02 Telephone Set Modification By Local Distributing House**

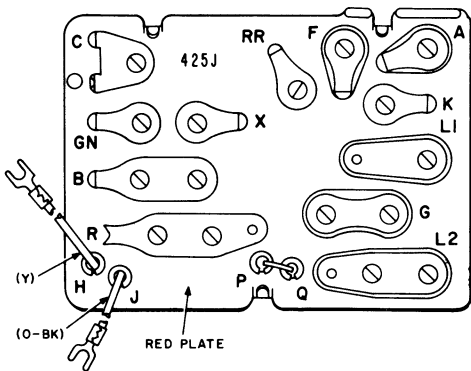

**Fig. 1—425J Network and Schematic**

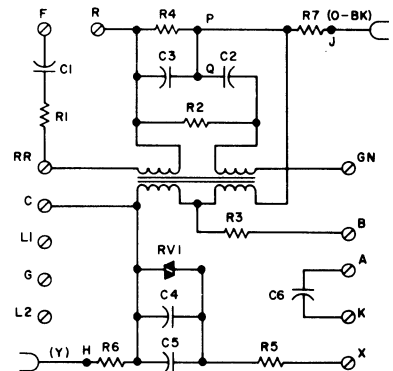

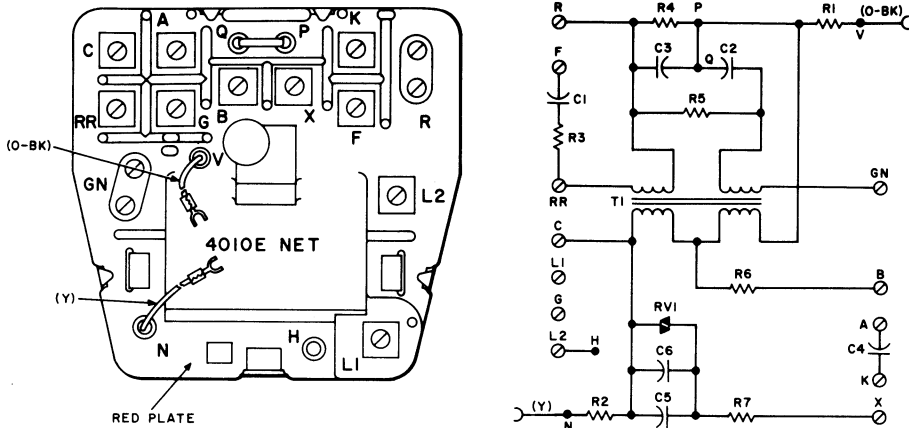

Fig. 2—4010E Network and Schematic

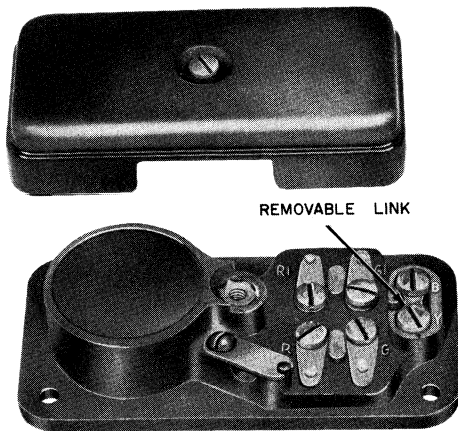

Fig. 3—1542A Inductor and Schematic

(a) Telephone sets, except coin, currently using the 425- or 4010-type networks will be modified as follows:

- Existing network replaced by a 425J or 4010E network, whichever is applicable
- TOUCH-TONE dial will have bypass capacitors installed across the varistors and transistors and will also have an additional (red-slate) lead soldered to the "X" terminal which in turn connects to the "X" terminal on the network.

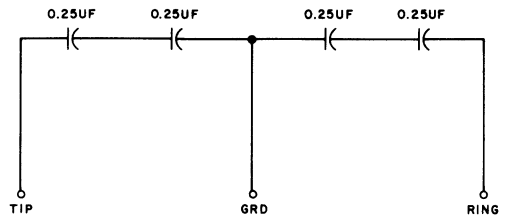
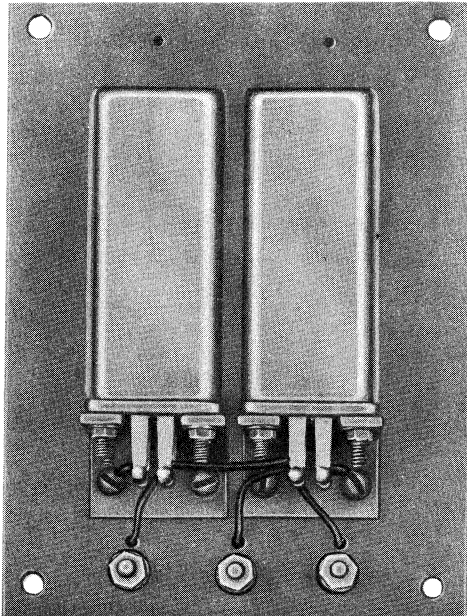

Fig. 4—40BA Capacitor and Schematic

- Bypass capacitors installed across all other components of the telephone set that may act as demodulators, such as transmitter unit, receiver unit, transistors in amplifiers, polarity guards, etc.

(b) TRIMLINE® telephones will be modified by having bypass capacitors placed across all the components in the set that may act as demodulators.

(c) Modified sets will not be recoded but will be identified in some manner by the local distributing house.

**2.03** TOUCH-TONE dials and all G-type handsets will be available from the local distributing house modified for radio suppression. These will be used where an adjunct dial must be installed or where the dial or handset must be replaced for maintenance reasons.

**2.04** Other modified telephone set components include 241B, 242B, and 277A amplifiers; D-180191 and D-180229 polarity guard assemblies; and 694A and B subsets. Modified versions of additional items will be made available in the future when they are needed.

### 3. ORDERING GUIDE

- Capacitor, 40BA
- Inductor 1542A—  
-49 Gray, -50 Ivory
- Set, Telephone—RF Modified
- Set, Telephone, Hand 220A—RF Modified
- Set, Telephone, Hand 2220B—Modified

## Replaceable Components

Dial—(TOUCH-TONE dial only) RF Modified  
Set, Hand G—RF Modified

## 4. INSTALLATION

### 4.01 Telephone Sets Equipped With 425J or 4010E Networks

- (a) Installed in usual manner
- (b) For connections see connection section of type set modified
- (c) Sets are shipped with speech equalization option leads insulated and stored:
  - (1) For loops greater than 500 ohms leave insulated and stored.
  - (2) For loops 500 ohms or less connect "H" or "N" (Yellow) and "J" or "V" (Orange-Black) leads to terminals RR and R, respectively, on the 425J or 4010E network.

### 4.02 Modified TRIMLINE Telephones

- (a) Install in usual manner
- (b) See Section 502-321-400 for connections

### 4.03 1542A Inductor (Fig. 5)

- (a) Use as connecting block for telephone set cord.
- (b) Locate as near as possible to wall-type sets.

### 4.04 40BA Capacitor (Fig. 6)

- (a) Install near and connect to protector with as short as possible piece of inside wire.
- (b) Station wires must connect to the capacitor
- (c) Mounted inside when outside protector is used
- (d) *Protector ground must be upgraded to the best possible ground available.*

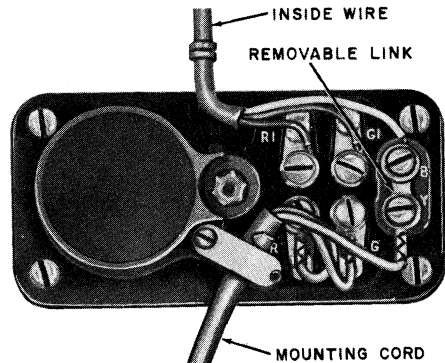

Fig. 5—Cording Diagram, 1542A Inductor

## 5. MAINTENANCE

- 5.01 Normal maintenance can be performed on modified telephone sets. Modified TOUCH-TONE dials and G-type handsets are available from the local distributing house for maintenance.

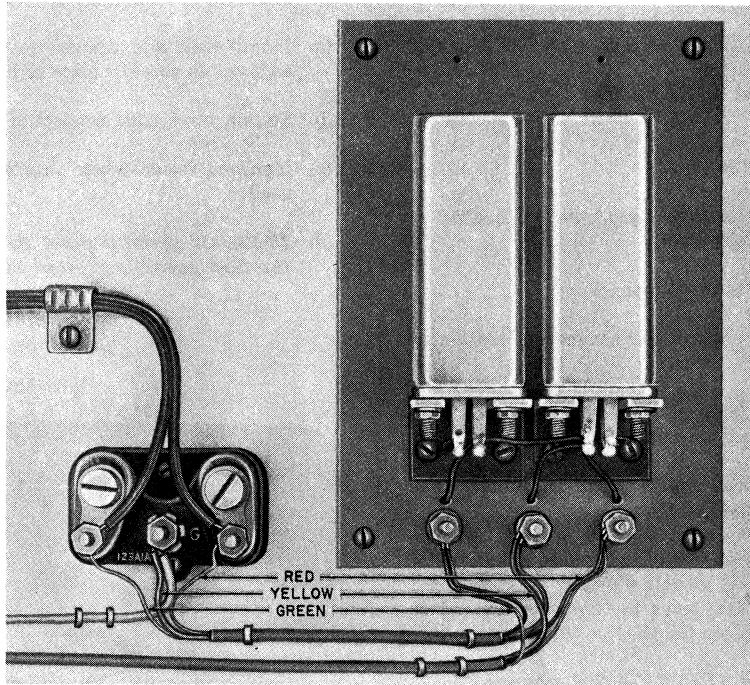

Fig. 6—123A1A Protector with 40BA Capacitor Installed